

SKF 71920 CD/P4AH1参数

主要尺寸	d	100	mm	-
	D	140	mm	-
	B	20	mm	-
基本额定载荷	C	60500	N	动载荷
	C_0	65500	N	静载荷
疲劳载荷极限	P_u	2550	N	-
可达转速	Grease	8500	r/min	-
	Oil-air	14000	r/min	-
重量	重量	800	g	-
型号	型号	71920 CD/P4AH1	-	-

SKF 71920 CD/P4AH1图片

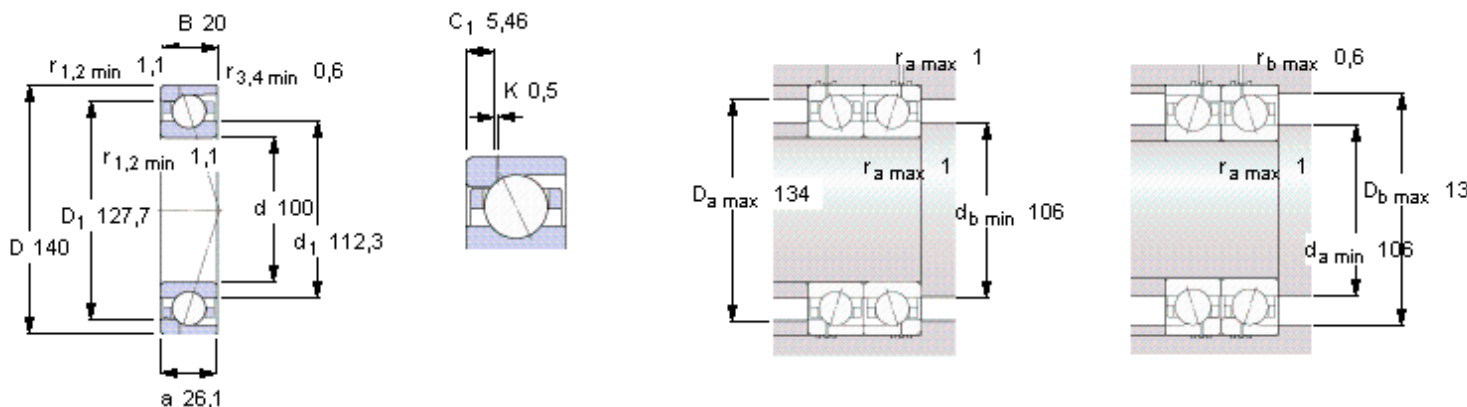

Ball diameter 12,7

Number of balls 26

未安装时的预载荷 [N]

背对背配置，面对面配置

预载荷等级

A	B	C	D
230	460	920	1840

Static axial stiffness [N/μm]

(guideline value)

预载荷等级

A	B	C	D
107	147	209	306

Reference grease quantity [cm³]

G_{ref} 11

计算系数

for equivalent bearing load

f_0 16,3

for preload in mounted bearing sets

f 1,23

f_1 1

f_{2A} 1

f_{2B} 1,04

f_{2C} 1,09

f_{2D} 1,15

f_{HC} 1

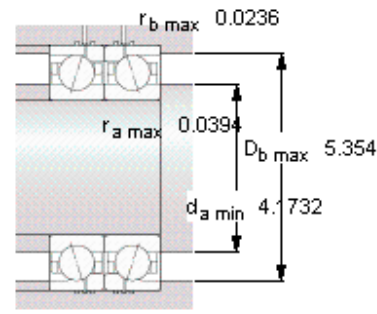
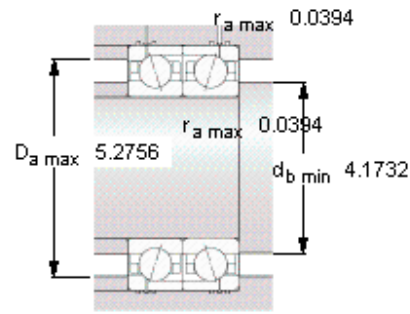
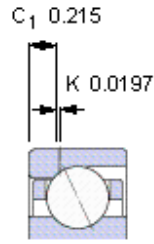
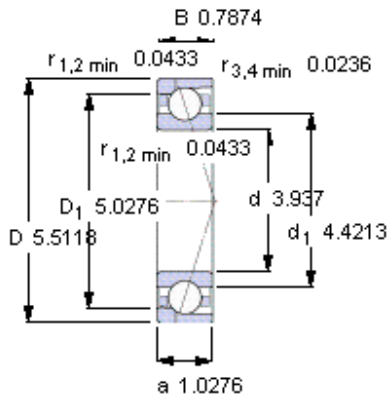

Ball diameter 12,7
Number of balls 26

未安装时的预载荷 [N]
 背对背配置，面对面配置
 预载荷等级

A	B	C	D
230	460	920	1840

Static axial stiffness [N/μm]
 (guideline value)

预载荷等级

A	B	C	D
107	147	209	306

Reference grease quantity [cm³]
 G_{ref} 11

计算系数
for equivalent bearing load
 f₀ 16,3

for preload in mounted bearing sets
 f 1,23
 f₁ 1
 f_{2A} 1
 f_{2B} 1,04
 f_{2C} 1,09
 f_{2D} 1,15
 f_{HC} 1