

FAG H241/1000-HG参数

尺寸	d_{1H}	950	mm	-
	D_m	1240	mm	-
	l	755	mm	-
	c	125	mm	-
	c_1	150	mm	-
	d	1000	mm	-
	d_{2G}	Tr1000x8	mm	-
	e	10	mm	-
	R_o	G1/8		-
	t	12	mm	-
说明		950	mm	轴
		HM31/1000		型号, 螺母
		MS31/1000		型号, 止动装置
		M24X45		型号, 六角头螺栓
重量	m	886000	g	质量

FAG H241/1000-HG图片

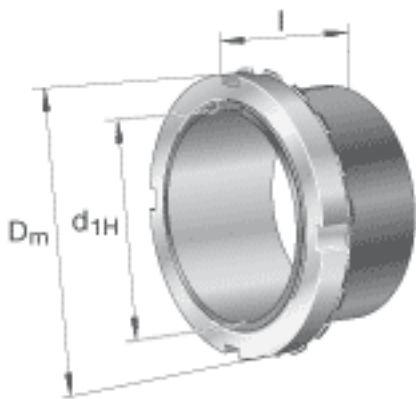

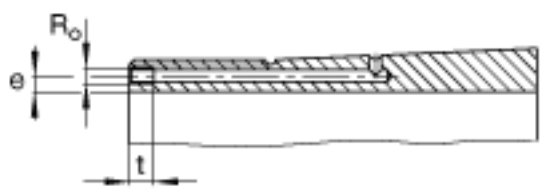
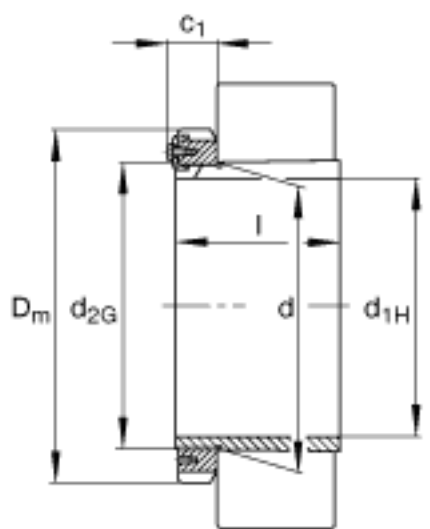

参考资料:<http://www.sozhou.com/p/116b4076.html>