

SKF S71908 CD/HCP4A参数

主要尺寸	d	40	mm	-
	D	62	mm	-
	B	12	mm	-
基本额定载荷	C	12400	N	动载荷
	C_0	8500	N	静载荷
疲劳载荷极限	P_u	360	N	-
可达转速	Grease	28000	r/min	-
	Oil-air	-	r/min	-
重量	重量	100	g	-
型号	型号	S71908 CD/HCP4A	-	-

SKF S71908 CD/HCP4A图片

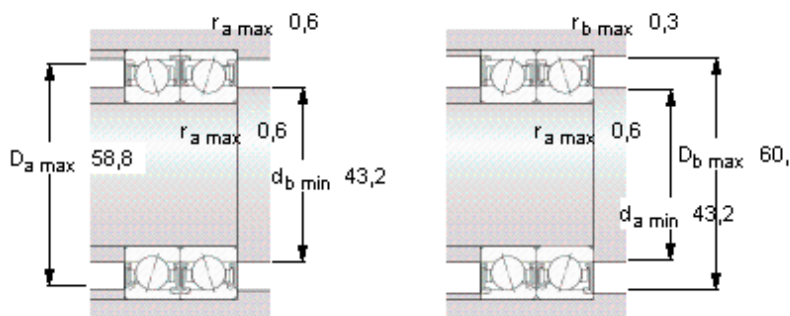
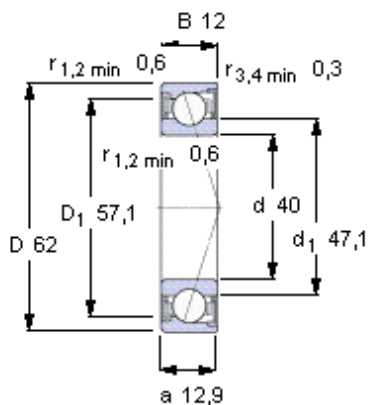

Ball diameter 6,35
Number of balls 21

未安装时的预载荷 [N]
背对背配置，面对面配置
预载荷等级

A	B	C	D
45	90	180	360

Static axial stiffness [N/μm]
(guideline value)

预载荷等级

A	B	C	D
40	54	73	103

Reference grease quantity [cm³]
 G_{ref} -

计算系数
for equivalent bearing load
 f_0 10,4

for preload in mounted bearing sets
f 1,09
 f_1 1
 f_{2A} 1
 f_{2B} 1,07
 f_{2C} 1,12
 f_{2D} 1,18
 f_{HC} 1,04

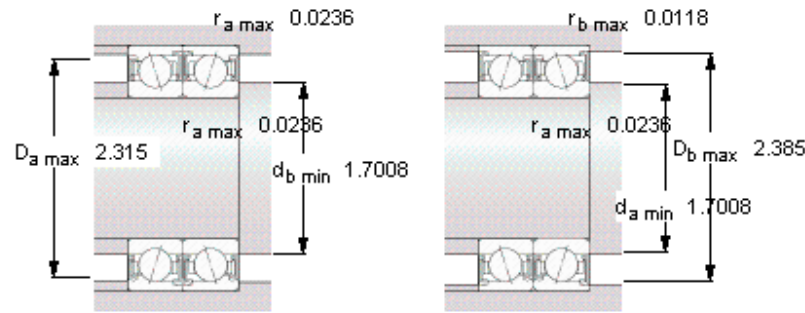
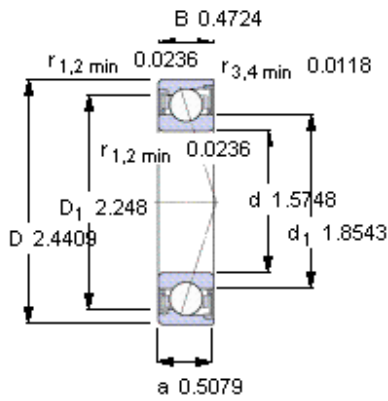

Ball diameter 6,35

Number of balls 21

未安装时的预载荷 [N]

背对背配置，面对面配置

预载荷等级

A	B	C	D
45	90	180	360

Static axial stiffness [N/μm]

(guideline value)

预载荷等级

A	B	C	D
40	54	73	103

Reference grease quantity [cm³]

G_{ref} -

计算系数

for equivalent bearing load

f₀ 10,4

for preload in mounted bearing sets

f 1,09

f₁ 1

f_{2A} 1

f_{2B} 1,07

f_{2C} 1,12

f_{2D} 1,18

f_{HC} 1,04