

SKF S7008 ACD/P4A参数

主要尺寸	d	40	mm	-
	D	68	mm	-
	B	15	mm	-
基本额定载荷	C	15900	N	动载荷
	C_0	10400	N	静载荷
疲劳载荷极限	P_u	440	N	-
可达转速	Grease	19000	r/min	-
	Oil-air	-	r/min	-
重量	重量	190	g	-
型号	型号	S7008 ACD/P4A	-	-

SKF S7008 ACD/P4A图片

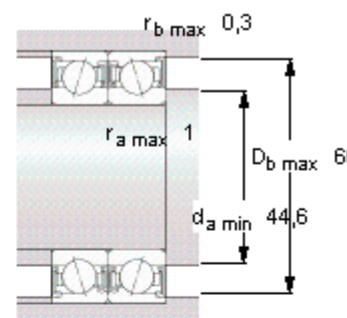
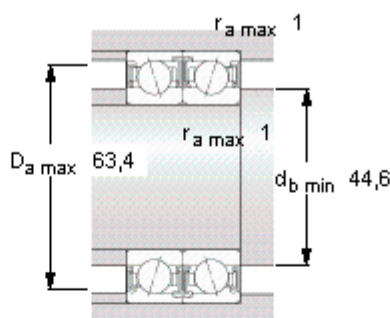
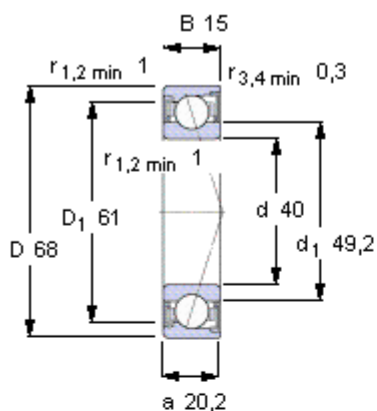

Ball diameter 7,938

Number of balls 18

未安装时的预载荷 [N]

背对背配置，面对面配置

预载荷等级

A	B	C	D
100	200	400	800

Static axial stiffness [N/μm]

(guideline value)

预载荷等级

A	B	C	D
96	124	162	214

Reference grease quantity [cm³]

G_{ref} -

计算系数

for equivalent bearing load

	单列，串联	背对背配置，面对面配置
e	0,68	0,68
X_1	1	1
Y_1	0	0,92
X_2	0,41	0,67
Y_2	0,87	1,41
X_0	0,5	1
Y_0	0,38	0,76

for preload in mounted bearing sets

f	1,06
f_1	0,99
f_{2A}	1
f_{2B}	1,02
f_{2C}	1,05
f_{2D}	1,08
f_{HC}	1

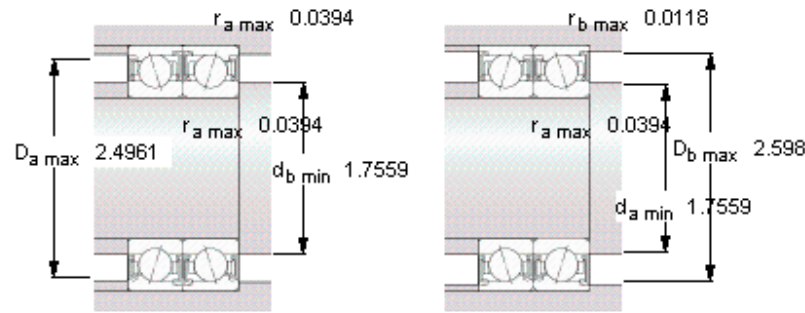
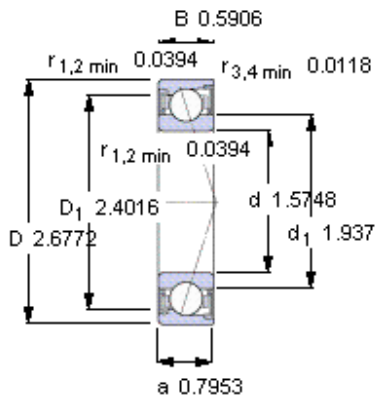

Ball diameter 7,938

Number of balls 18

未安装时的预载荷 [N]

背对背配置，面对面配置

预载荷等级

A	B	C	D
100	200	400	800

Static axial stiffness [N/μm]

(guideline value)

预载荷等级

A	B	C	D
96	124	162	214

Reference grease quantity [cm³]

G_{ref} -

计算系数

for equivalent bearing load

	单列，串联	背对背配置，面对面配置
e	0,68	0,68
X ₁	1	1
Y ₁	0	0,92
X ₂	0,41	0,67
Y ₂	0,87	1,41
X ₀	0,5	1
Y ₀	0,38	0,76

for preload in mounted bearing sets

f	1,06
f ₁	0,99
f _{2A}	1
f _{2B}	1,02
f _{2C}	1,05
f _{2D}	1,08
f _{HC}	1