

### SKF 71922 CD/P4AH1参数

主要尺寸	d	110	mm	-
	D	150	mm	-
	B	20	mm	-
基本额定载荷	C	62400	N	动载荷
	$C_0$	72000	N	静载荷
疲劳载荷极限	$P_u$	2700	N	-
可达转速	Grease	8000	r/min	-
	Oil-air	13000	r/min	-
重量	重量	860	g	-
型号	型号	71922 CD/P4AH1	-	-

### SKF 71922 CD/P4AH1图片

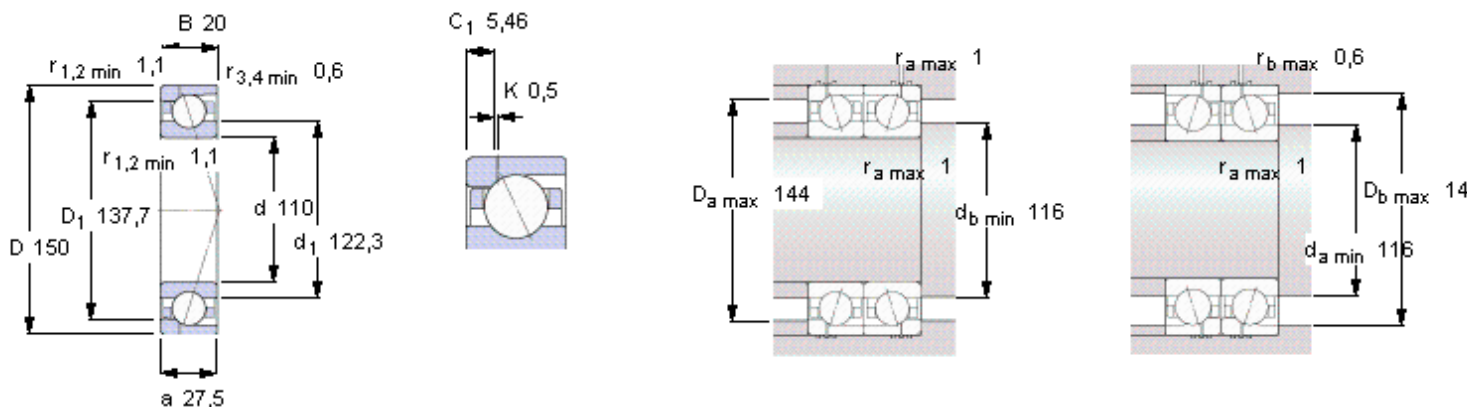

**Ball diameter** 12,7

**Number of balls** 28

#### 未安装时的预载荷 [N]

背对背配置，面对面配置

预载荷等级

A	B	C	D
230	460	920	1840

#### Static axial stiffness [N/ $\mu\text{m}$ ]

(guideline value)

预载荷等级

A	B	C	D
113	156	221	325

#### Reference grease quantity [cm<sup>3</sup>]

$G_{\text{ref}}$  11

#### 计算系数

for equivalent bearing load

$f_0$  16,5

for preload in mounted bearing sets

$f$  1,26

$f_1$  1

$f_{2A}$  1

$f_{2B}$  1,04

$f_{2C}$  1,09

$f_{2D}$  1,15

$f_{HC}$  1

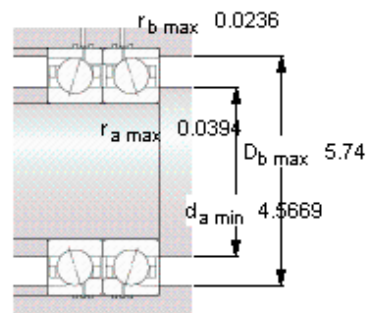
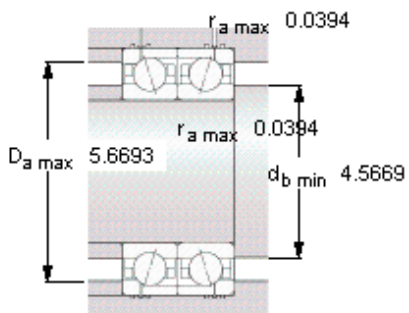
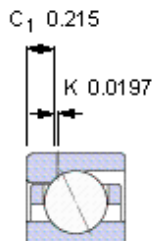
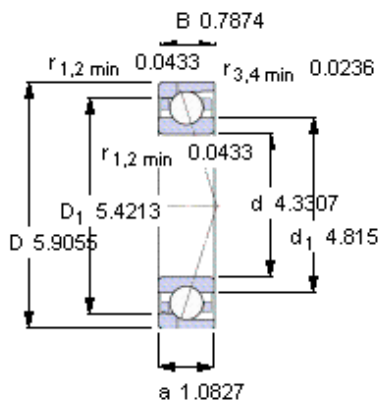

**Ball diameter** 12,7

**Number of balls** 28

**未安装时的预载荷 [N]**

背对背配置，面对面配置

预载荷等级

A	B	C	D
230	460	920	1840

**Static axial stiffness [N/μm]**

(guideline value)

预载荷等级

A	B	C	D
113	156	221	325

**Reference grease quantity [cm<sup>3</sup>]**

G<sub>ref</sub> 11

**计算系数**

for equivalent bearing load

f<sub>0</sub> 16,5

for preload in mounted bearing sets

f 1,26

f<sub>1</sub> 1

f<sub>2A</sub> 1

f<sub>2B</sub> 1,04

f<sub>2C</sub> 1,09

f<sub>2D</sub> 1,15

f<sub>HC</sub> 1