

SKF S71913 CB/HCP4A参数

主要尺寸	d	65	mm	-
	D	90	mm	-
	B	13	mm	-
基本额定载荷	C	10600	N	动载荷
	C_0	9500	N	静载荷
疲劳载荷极限	P_u	400	N	-
可达转速	Grease	24000	r/min	-
	Oil-air	-	r/min	-
重量	重量	200	g	-
型号	型号	S71913 CB/HCP4A	-	-

SKF S71913 CB/HCP4A图片

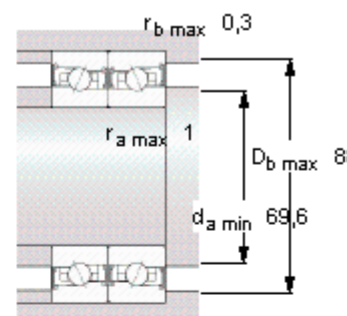
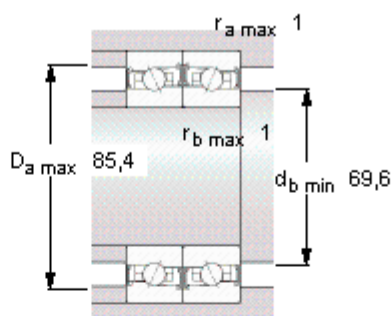
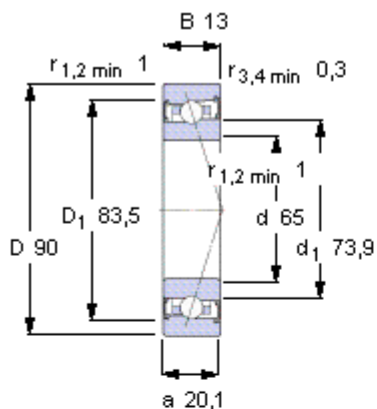

Ball diameter 5,556

Number of balls 32

未安装时的预载荷 [N]

背对背配置，面对面配置

预载荷等级

A	B	C	D
35	70	210	-

Static axial stiffness [N/μm]

(guideline value)

预载荷等级

A	B	C	D
43	56	90	-

Reference grease quantity [cm³]

G_{ref} -

计算系数

for equivalent bearing load

f_0 9,9

for preload in mounted bearing sets

f 1,13

f_1 1

f_{2A} 1

f_{2B} 1,03

f_{2C} 1,08

f_{2D} -

f_{HC} 1,01

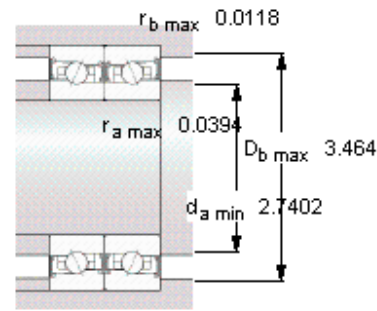
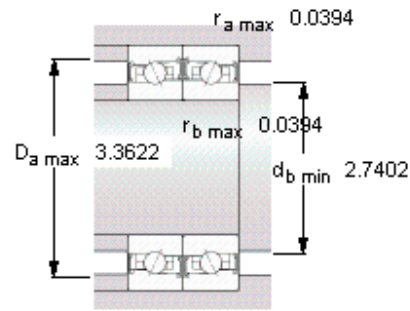
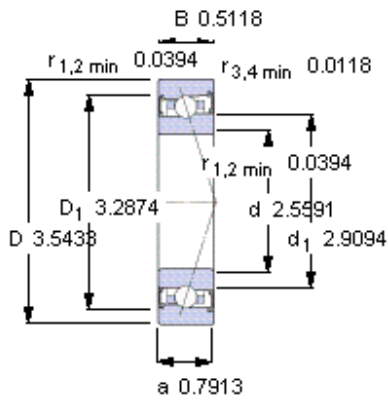

Ball diameter 5,556

Number of balls 32

未安装时的预载荷 [N]

背对背配置，面对面配置

预载荷等级

A	B	C	D
35	70	210	-

Static axial stiffness [N/μm]

(guideline value)

预载荷等级

A	B	C	D
43	56	90	-

Reference grease quantity [cm³]

G_{ref} -

计算系数

for equivalent bearing load

f₀ 9,9

for preload in mounted bearing sets

f 1,13

f₁ 1

f_{2A} 1

f_{2B} 1,03

f_{2C} 1,08

f_{2D} -

f_{HC} 1,01