

SKF 7020 CE/HCP4AH1参数

主要尺寸	d	100	mm	-
	D	150	mm	-
	B	24	mm	-
基本额定载荷	C	44900	N	动载荷
	C_0	40000	N	静载荷
疲劳载荷极限	P_u	1500	N	-
可达转速	Grease	14500	r/min	-
	Oil-air	22000	r/min	-
重量	重量	1100	g	-
型号	型号	7020 CE/HCP4AH1	-	-

SKF 7020 CE/HCP4AH1图片

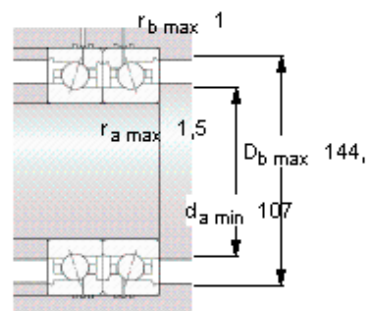
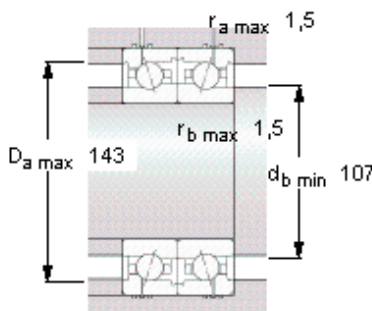
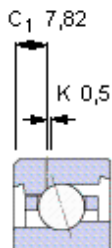
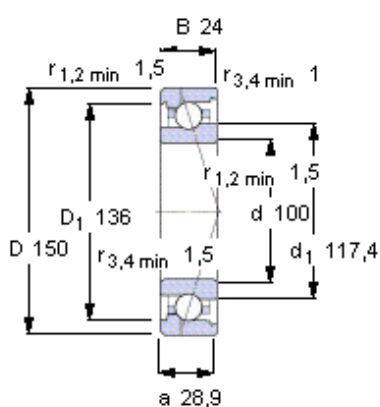

Ball diameter 12,7

Number of balls 27

未安装时的预载荷 [N]

背对背配置，面对面配置

预载荷等级

A	B	C	D
240	720	1440	-

Static axial stiffness [N/μm]

(guideline value)

预载荷等级

A	B	C	D
97	154	212	-

Reference grease quantity [cm³]

G_{ref} 17

计算系数

for equivalent bearing load

f_0 9,5

for preload in mounted bearing sets

f 1,12

f_1 1

f_{2A} 1

f_{2B} 1,03

f_{2C} 1,05

f_{2D} -

f_{HC} 1,01

参考资料: <http://www.sozhou.com/p/3c2baded.html>

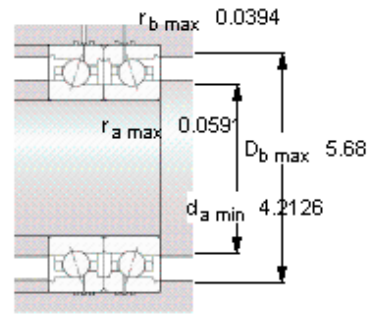
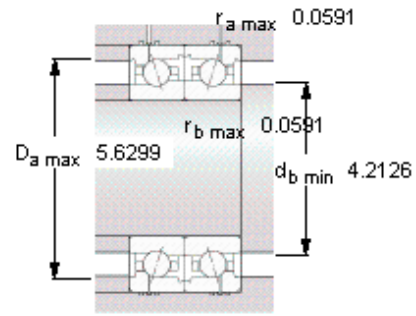
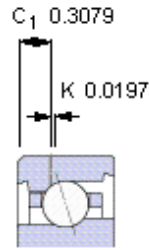
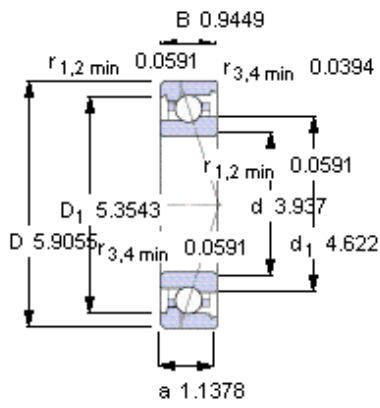

Ball diameter 12,7
Number of balls 27

未安装时的预载荷 [N]
 背对背配置，面对面配置
 预载荷等级

A	B	C	D
240	720	1440	-

Static axial stiffness [N/μm]
 (guideline value)

预载荷等级

A	B	C	D
97	154	212	-

Reference grease quantity [cm³]
 G_{ref} 17

计算系数
for equivalent bearing load
 f₀ 9,5

for preload in mounted bearing sets
 f 1,12
 f₁ 1
 f_{2A} 1
 f_{2B} 1,03
 f_{2C} 1,05
 f_{2D} -
 f_{HC} 1,01