

SKF 7030 CD/P4A参数

主要尺寸	d	150	mm	-
	D	225	mm	-
	B	35	mm	-
基本额定载荷	C	172000	N	动载荷
	C_0	190000	N	静载荷
疲劳载荷极限	P_u	5850	N	-
可达转速	Grease	6000	r/min	-
	Oil-air	9000	r/min	-
重量	重量	4150	g	-
型号	型号	7030 CD/P4A	-	-

SKF 7030 CD/P4A图片

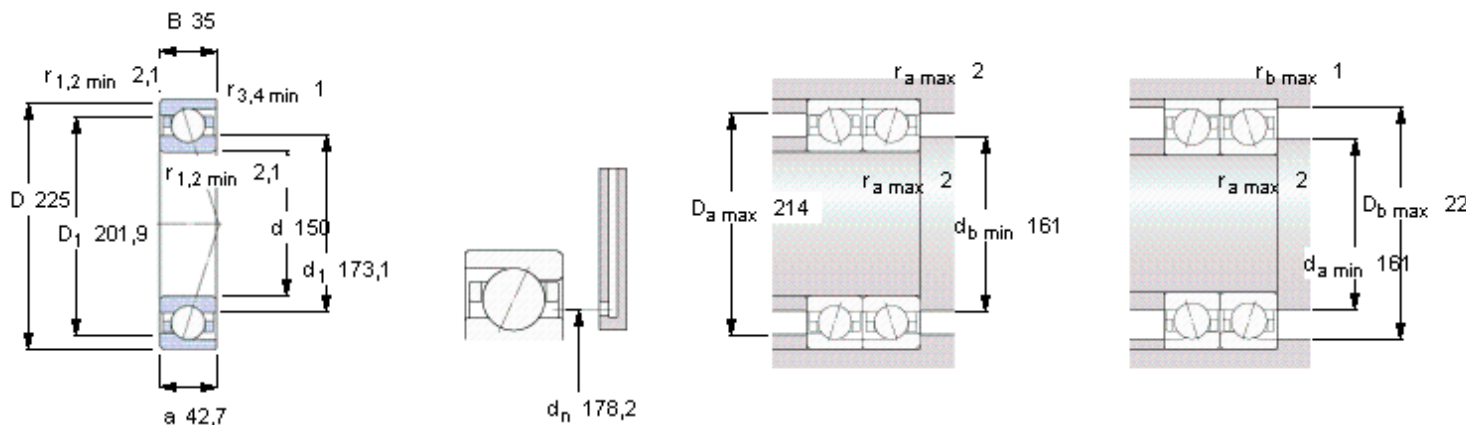

Ball diameter 23,812

Number of balls 22

未安装时的预载荷 [N]

背对背配置，面对面配置

预载荷等级

A	B	C	D
650	1300	2600	5200

Static axial stiffness [N/ μ m]

(guideline value)

预载荷等级

A	B	C	D
163	221	310	449

Reference grease quantity [cm³]

G_{ref} 54

计算系数

for equivalent bearing load

f_0 15,8

for preload in mounted bearing sets

f 1,16

f_1 1

f_{2A} 1

f_{2B} 1,02

f_{2C} 1,05

f_{2D} 1,09

f_{HC} 1

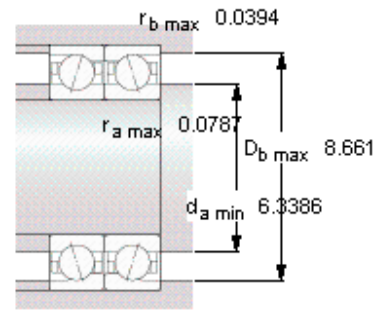
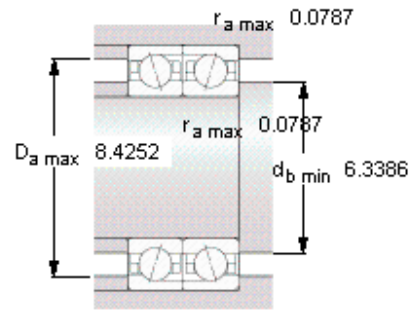
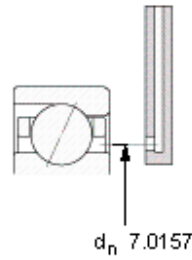
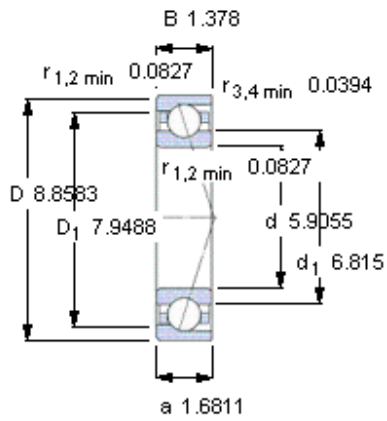

Ball diameter 23,812

Number of balls 22

未安装时的预载荷 [N]

背对背配置，面对面配置

预载荷等级

A	B	C	D
650	1300	2600	5200

Static axial stiffness [N/μm]

(guideline value)

预载荷等级

A	B	C	D
163	221	310	449

Reference grease quantity [cm³]

G_{ref} 54

计算系数

for equivalent bearing load

f₀ 15,8

for preload in mounted bearing sets

f 1,16

f₁ 1

f_{2A} 1

f_{2B} 1,02

f_{2C} 1,05

f_{2D} 1,09

f_{HC} 1