

SKF 81152 M参数

主要尺寸	d	260	mm	-
	D	320	mm	-
	H	45	mm	-
基本额定载荷	C	490000	N	动载荷
	C_0	2600000	N	静载荷
疲劳载荷极限	P_u	200000	N	-
最小载荷系数	A	0.54	-	-
额定转速	额定转度	530	r/min	-
	极限转速	1100	r/min	-
重量	重量	7850	g	-
型号	完整轴承	81152 M	-	-
	滚子和保持架推力组件	K 81152 M	-	-

SKF 81152 M图片

完整轴承

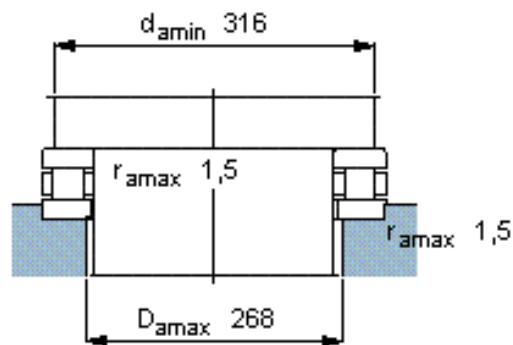
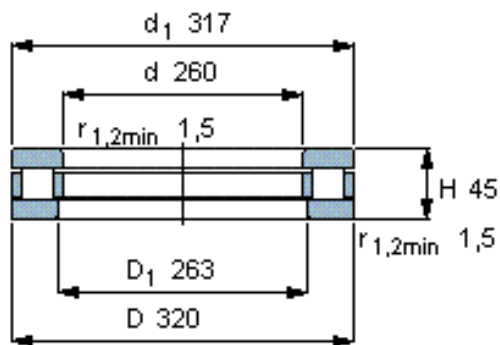

滚子和保持架推力组件

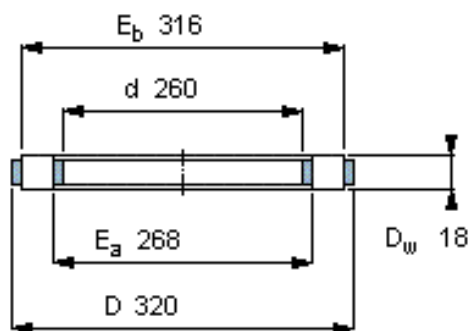

适宜的部件

轴垫圈
WS 81152

轴承座垫圈
GS 81152

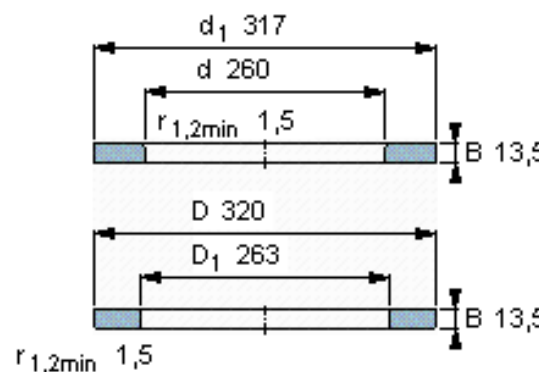

K 81152 M

质量 kg 2,25

完整轴承

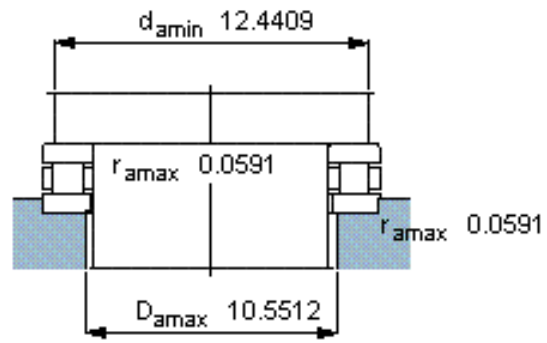
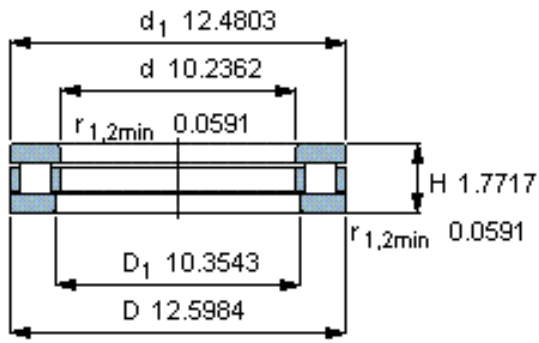

滚子和保持架推力组件

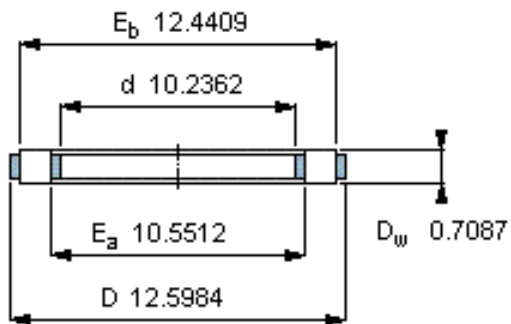

K 81152 M

质量 kg 2,25

适宜的部件

轴垫圈
WS 81152

轴承座垫圈
GS 81152

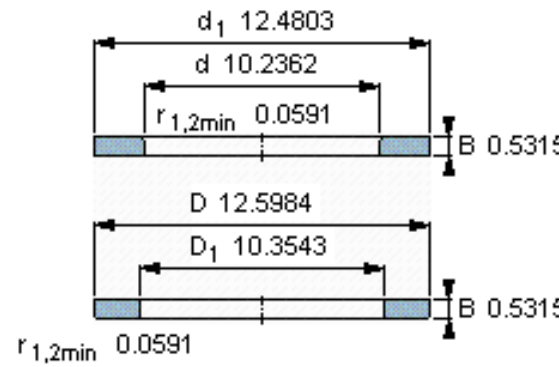

参考资料: <http://www.sozhou.com/p/5e7fe9d3.html>