

KOYO LM603049/12参数

型号	ORDER	LM603049/12		型号
主要尺寸	SD	45.242	mm	内径
	D	77.788	mm	外径
	T	21.430	mm	-
	B	19.842	mm	宽度
	C	16.667	mm	宽度
	R	3.60	mm	(最小)
	基本额定载荷	CR	57100	N
CO		73500	N	静载荷
极限转速	NG	4900	1/min	脂润滑
	NO	6500	1/min	油润滑

KOYO LM603049/12图片

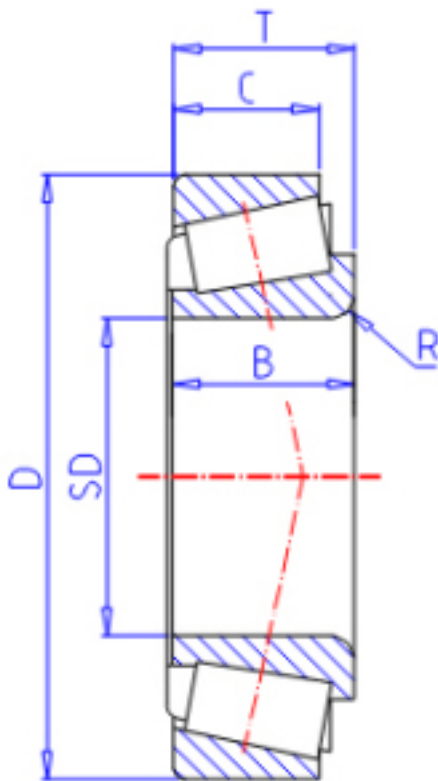

参考资料:<http://www.sozhou.com/p/5e975749.html>

