

SKF 53206参数

主要尺寸	d	30	mm	-
	D	52	mm	-
	H ₁	20	mm	-
基本额定载荷	C	25500	N	动载荷
	C ₀	51000	N	静载荷
疲劳载荷极限	P _u	1900	N	-
最小载荷系数	A	0.013	-	-
额定转速	额定转度	4800	r/min	-
	极限转速	6700	r/min	-
重量	轴承+垫圈	180	g	-
型号	轴承	53206	-	-
	座圈	U 206	-	-

SKF 53206图片

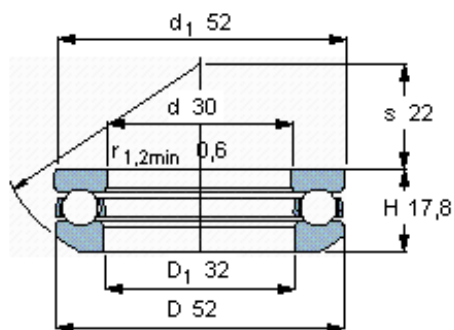

垫圈的球面曲率半径

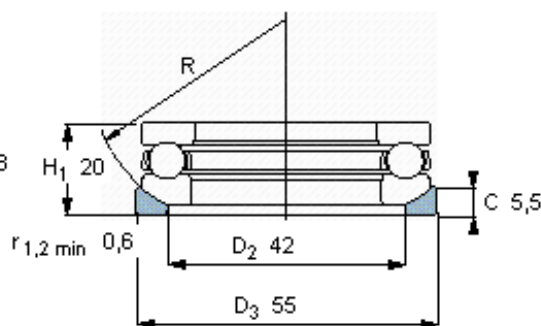

R 45

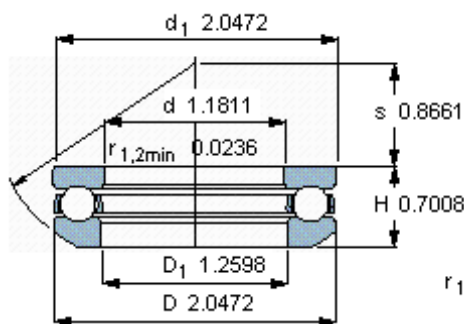
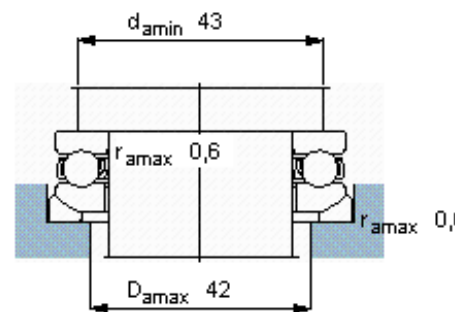

垫圈的球面曲率半径

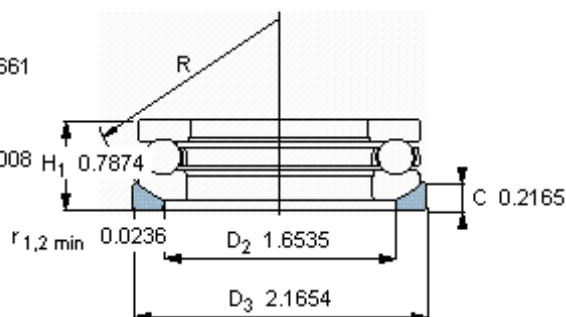

R 1.7717

