

SKF S7015 CD/HCP4A参数

主要尺寸	d	75	mm	-
	D	115	mm	-
	B	20	mm	-
基本额定载荷	C	52700	N	动载荷
	C_0	49000	N	静载荷
疲劳载荷极限	P_u	2080	N	-
可达转速	Grease	14000	r/min	-
	Oil-air	-	r/min	-
重量	重量	540	g	-
型号	型号	S7015 CD/HCP4A	-	-

SKF S7015 CD/HCP4A图片

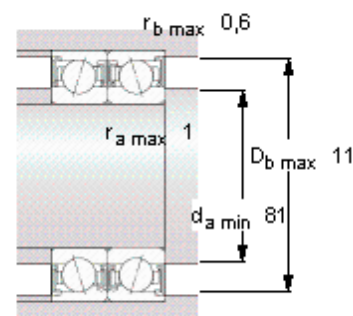
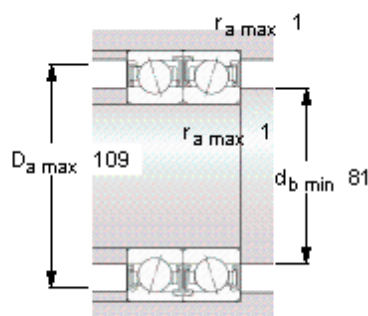
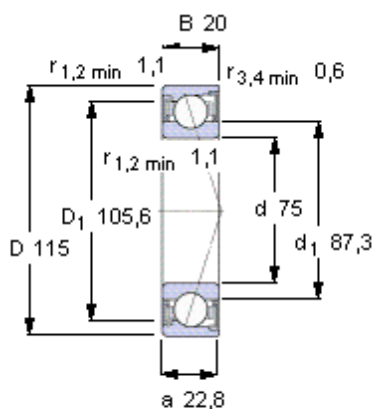

Ball diameter 12,7

Number of balls 20

未安装时的预载荷 [N]

背对背配置，面对面配置

预载荷等级

A	B	C	D
200	400	800	1600

Static axial stiffness [N/μm]

(guideline value)

预载荷等级

A	B	C	D
93	128	179	260

Reference grease quantity [cm³]

G_{ref} -

计算系数

for equivalent bearing load

f_0 15,7

for preload in mounted bearing sets

f 1,14

f_1 1

f_{2A} 1

f_{2B} 1,02

f_{2C} 1,05

f_{2D} 1,09

f_{HC} 1,02

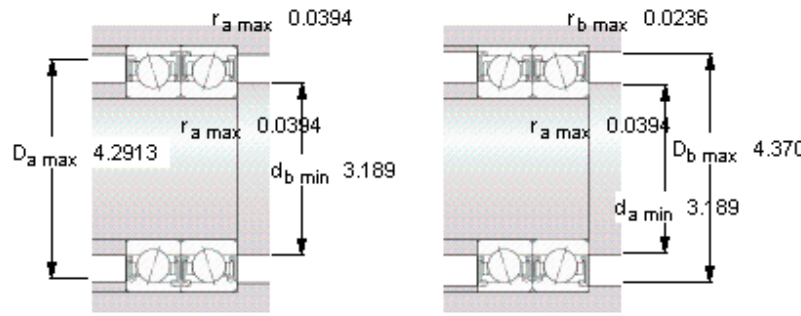
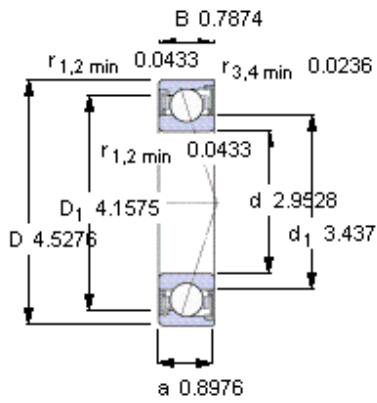

Ball diameter 12,7

Number of balls 20

未安装时的预载荷 [N]

背对背配置，面对面配置

预载荷等级

A	B	C	D
200	400	800	1600

Static axial stiffness [N/μm]

(guideline value)

预载荷等级

A	B	C	D
93	128	179	260

Reference grease quantity [cm³]

G_{ref} -

计算系数

for equivalent bearing load

f₀ 15,7

for preload in mounted bearing sets

f 1,14

f₁ 1

f_{2A} 1

f_{2B} 1,02

f_{2C} 1,05

f_{2D} 1,09

f_{HC} 1,02