

SKF 71922 CD/HCP4AL 参数

主要尺寸	d	110	mm	-
	D	150	mm	-
	B	20	mm	-
基本额定载荷	C	62400	N	动载荷
	C_0	72000	N	静载荷
疲劳载荷极限	P_u	2700	N	-
可达转速	Grease	10000	r/min	-
	Oil-air	16000	r/min	-
重量	重量	730	g	-
型号	型号	71922 CD/HCP4AL	-	-

SKF 71922 CD/HCP4AL 图片

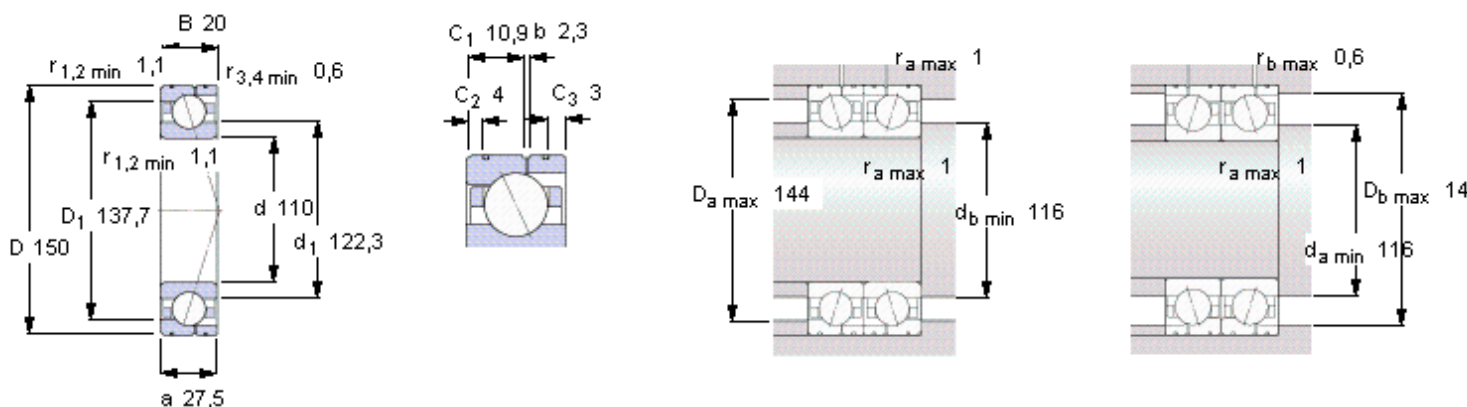

Ball diameter 12,7

Number of balls 28

未安装时的预载荷 [N]

背对背配置，面对面配置

预载荷等级

A	B	C	D
230	460	920	1840

Static axial stiffness [N/μm]

(guideline value)

预载荷等级

A	B	C	D
126	173	245	361

Reference grease quantity [cm³]

G_{ref} 11

计算系数

for equivalent bearing load

f_0 16,5

for preload in mounted bearing sets

f 1,26

f_1 1

f_{2A} 1

f_{2B} 1,07

f_{2C} 1,12

f_{2D} 1,18

f_{HC} 1,04

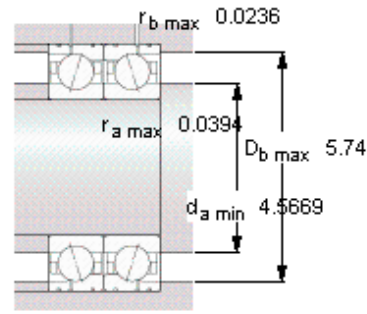
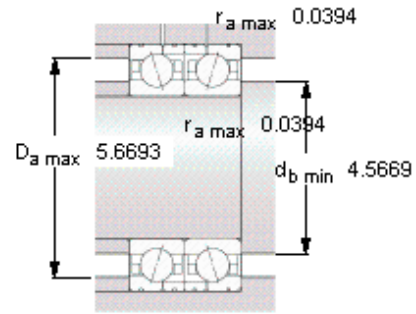
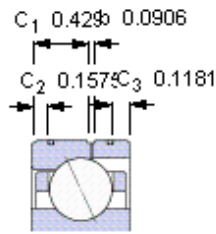
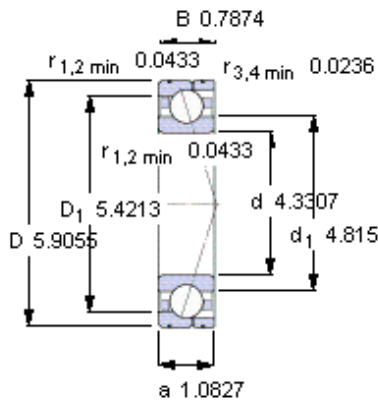

Ball diameter 12,7
Number of balls 28

未安装时的预载荷 [N]
 背对背配置，面对面配置
 预载荷等级

A	B	C	D
230	460	920	1840

Static axial stiffness [N/μm]
 (guideline value)

预载荷等级

A	B	C	D
126	173	245	361

Reference grease quantity [cm³]
 G_{ref} 11

计算系数
 for equivalent bearing load
 f₀ 16,5

for preload in mounted bearing sets
 f 1,26
 f₁ 1
 f_{2A} 1
 f_{2B} 1,07
 f_{2C} 1,12
 f_{2D} 1,18
 f_{HC} 1,04