

NACHI UCTU317+WU500参数

外形尺寸	H	165	mm	-
	H2	325	mm	-
	L	1020	mm	-
	J	960	mm	-
	L2	230	mm	-
	L3	500	mm	-
安装尺寸	d1	85	mm	-
	B	96	mm	-
	S	40	mm	-
重量	Mass	49800	g	重量
基本额定载荷	Cr	132000	N	动载荷
	Cor	96500	N	静载荷
极限速度	Grease	-	r/min	脂润滑
	Oil	-	r/min	油润滑

NACHI UCTU317+WU500图片

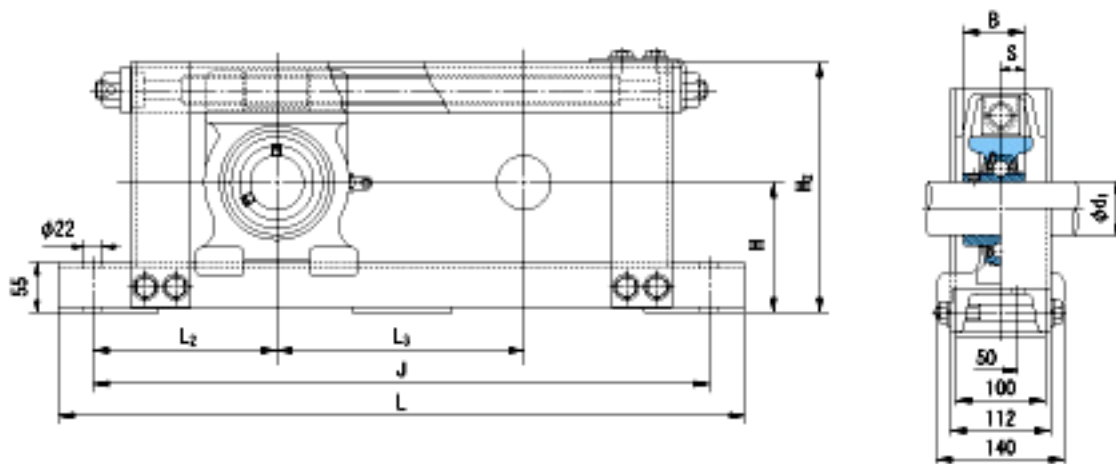

参考资料:<http://www.sozhou.com/p/89431507.html>