

SKF 81252 M参数

主要尺寸	d	260	mm	-
	D	360	mm	-
	H	79	mm	-
基本额定载荷	C	1140000	N	动载荷
	C_0	5300000	N	静载荷
疲劳载荷极限	P_u	415000	N	-
最小载荷系数	A	2.2	-	-
额定转速	额定转度	380	r/min	-
	极限转速	750	r/min	-
重量	重量	24000	g	-
型号	完整轴承	81252 M	-	-
	滚子和保持架推力组件	K 81252 M	-	-

SKF 81252 M图片

完整轴承

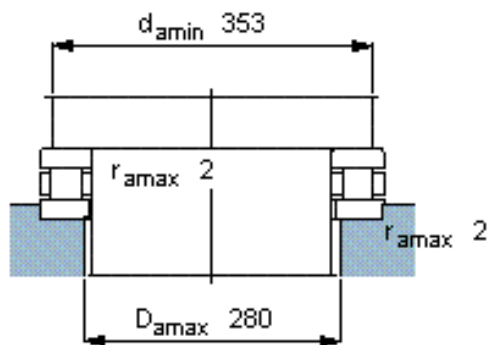
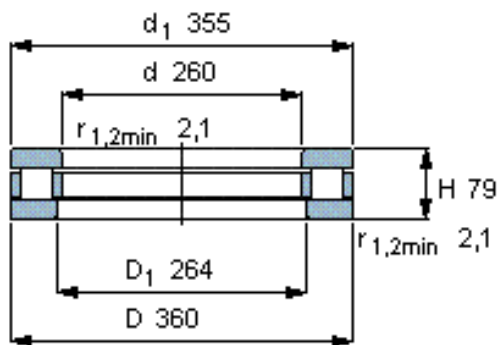

滚子和保持架推力组件

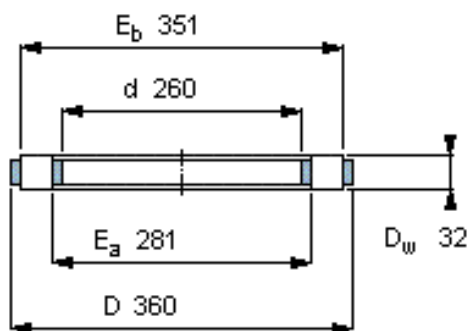

K 81252 M

质量 kg 6,66

适宜的部件

轴垫圈
WS 81252

轴承座垫圈
GS 81252

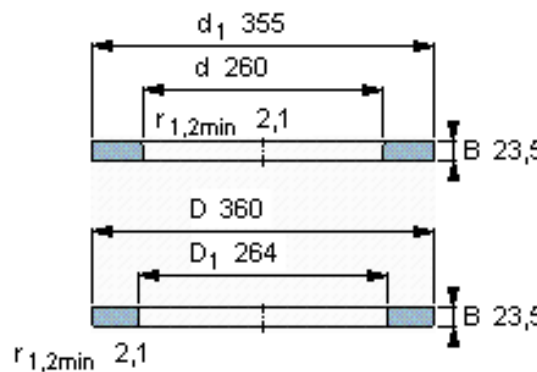

完整轴承

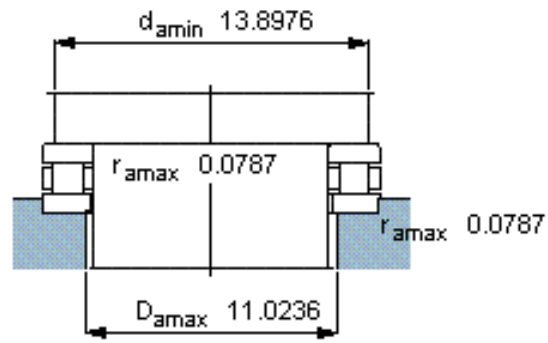
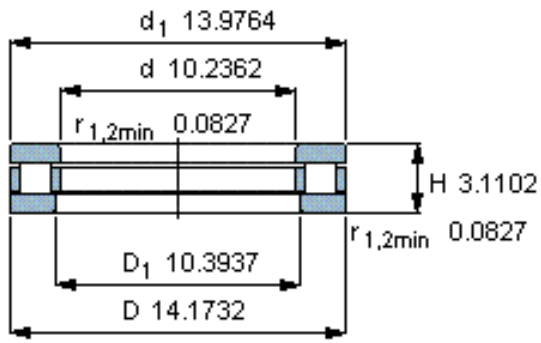

滚子和保持架推力组件

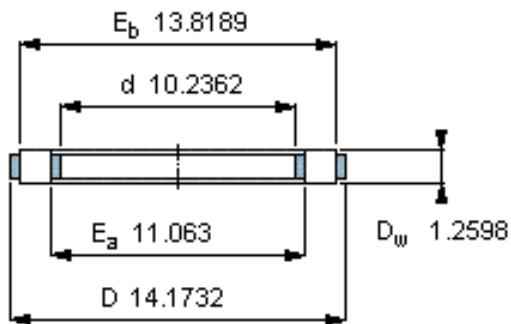

K 81252 M

质量 kg 6,66

适宜的部件

轴垫圈
WS 81252

轴承座垫圈
GS 81252

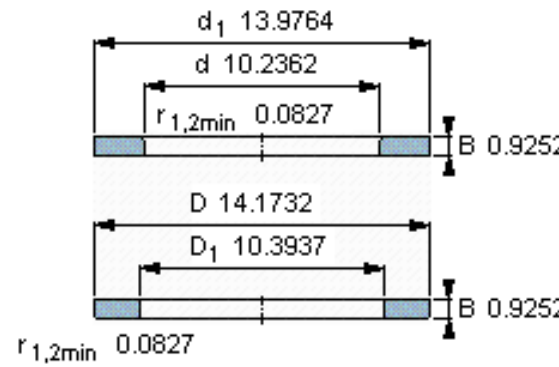

参考资料: <http://www.sozhou.com/p/92f44cbc.html>