

SKF 71913 CD/HCP4AL 参数

主要尺寸	d	65	mm	-
	D	90	mm	-
	B	13	mm	-
基本额定载荷	C	20800	N	动载荷
	C_0	17000	N	静载荷
疲劳载荷极限	P_u	710	N	-
可达转速	Grease	17000	r/min	-
	Oil-air	26000	r/min	-
重量	重量	170	g	-
型号	型号	71913 CD/HCP4AL	-	-

SKF 71913 CD/HCP4AL 图片

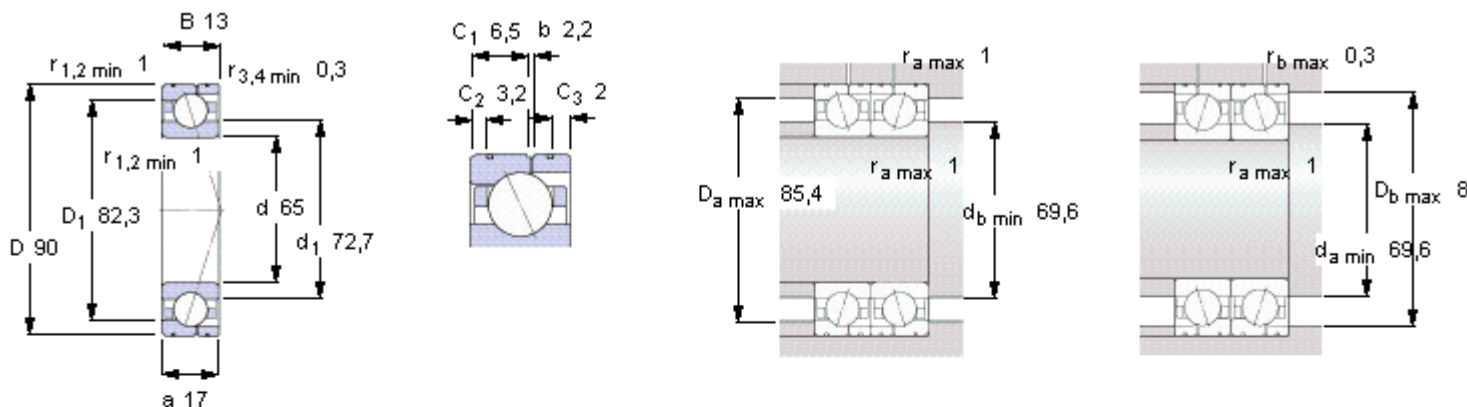

Ball diameter 7,938

Number of balls 26

未安装时的预载荷 [N]

背对背配置，面对面配置

预载荷等级

A	B	C	D
80	160	320	640

Static axial stiffness [N/ μm]

(guideline value)

预载荷等级

A	B	C	D
62	84	115	164

Reference grease quantity [cm³]

G_{ref} 2,9

计算系数

for equivalent bearing load

f_0 10,7

for preload in mounted bearing sets

f 1,2

f_1 1

f_{2A} 1

f_{2B} 1,07

f_{2C} 1,12

f_{2D} 1,18

f_{HC} 1,04

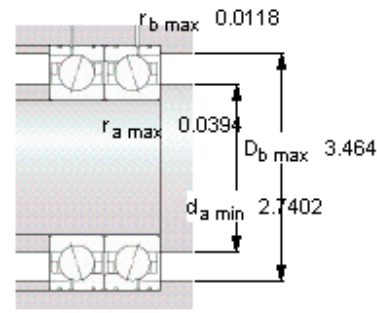
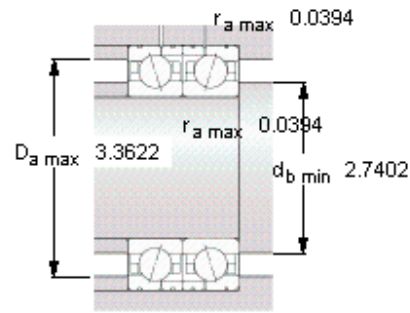
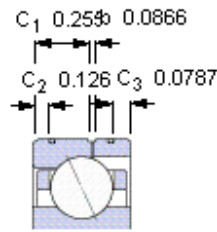
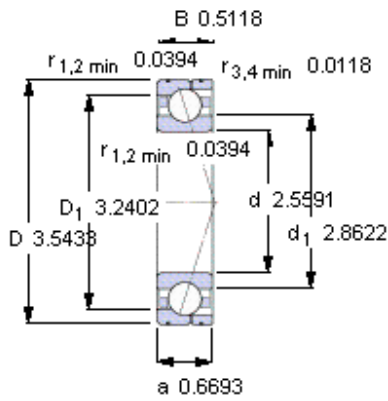

Ball diameter 7,938

Number of balls 26

未安装时的预载荷 [N]

背对背配置，面对面配置

预载荷等级

A	B	C	D
80	160	320	640

Static axial stiffness [N/μm]

(guideline value)

预载荷等级

A	B	C	D
62	84	115	164

Reference grease quantity [cm³]

G_{ref} 2,9

计算系数

for equivalent bearing load

f₀ 10,7

for preload in mounted bearing sets

f 1,2

f₁ 1

f_{2A} 1

f_{2B} 1,07

f_{2C} 1,12

f_{2D} 1,18

f_{HC} 1,04