

TIMKEN 170RU93参数

轴承型号	Part Number	170RU93		-
	Subtype	NU		-
尺寸	d	170	mm	内径
	D	359.999	mm	外径
	B	139.7	mm	宽度
额定载荷	C1	2104009	N	一百万转动态径向载荷
	C0	2562176	N	静态额定载荷
几何结构系数	Cg	0.2222		几何系数
极限转速	oil	2700		润滑油
	grease	2200		润滑脂
尺寸	R	3.048	mm	最大轴肩倒角半径
	da	204.978	mm	轴肩直径
	r	3.048	mm	最大轴承座挡肩圆角半径
	Da	325.12	mm	轴承座挡肩直径
重量	Assembly Weight	73663.40	g	-

TIMKEN 170RU93图片

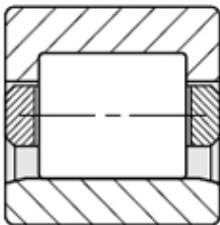
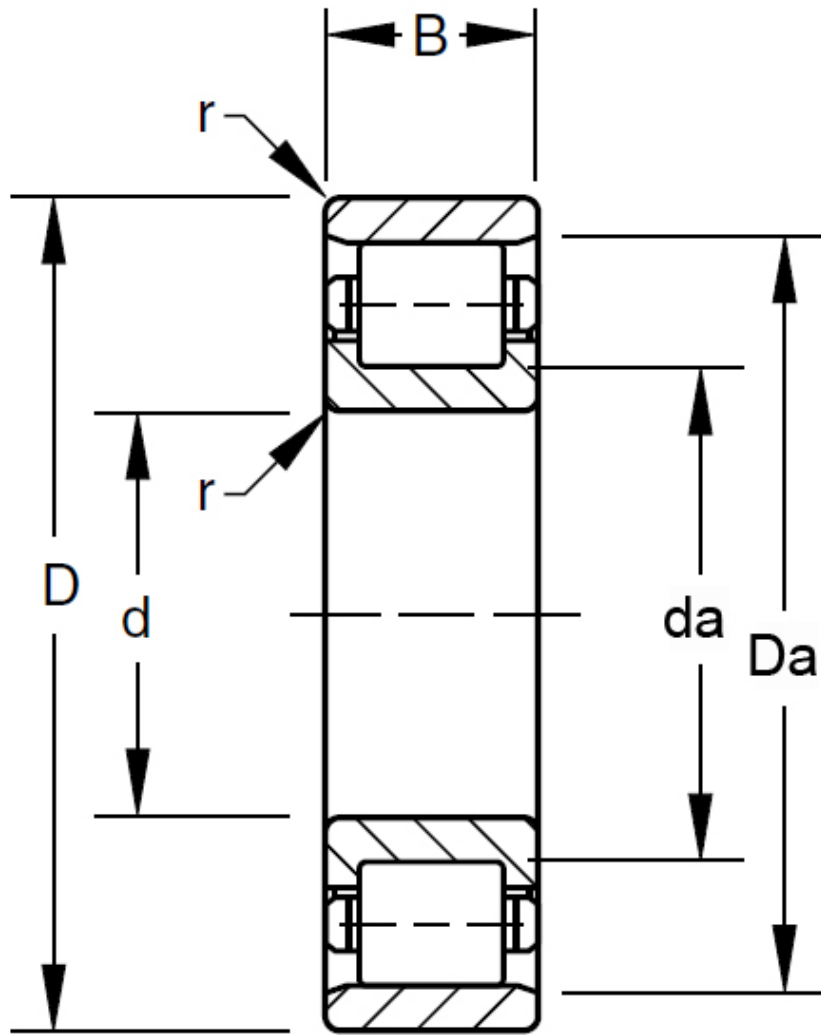

RU
RIU

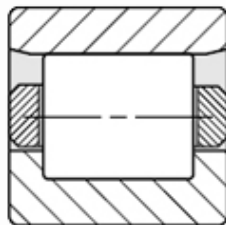

RN
RIN

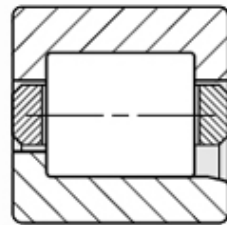

RJ
RIJ

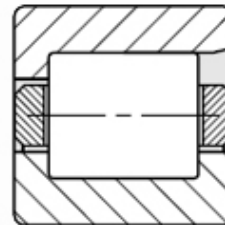

RF
RIF

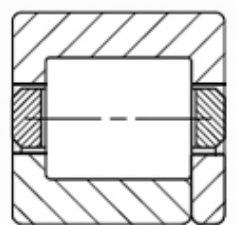

RT
RIT

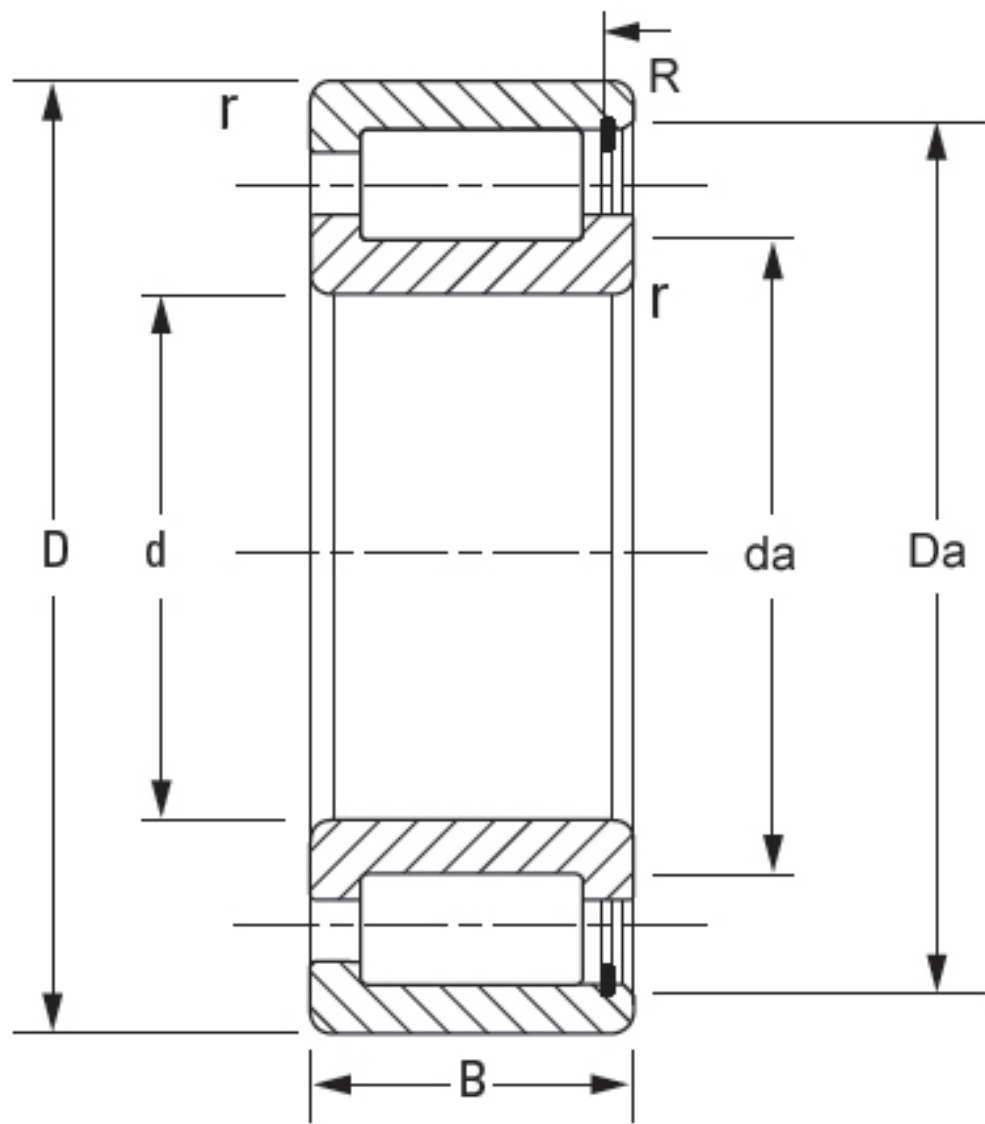

NCF