

SKF FYNT 90 F参数

主要尺寸	d	90	mm	-
	A ₁	92	mm	-
	J	198	mm	-
	L	250	mm	-
	T	93.5	mm	-
基本额定载荷	C	325000	N	动载荷
	C ₀	375000	N	静载荷
疲劳载荷极限	P _u	39000	N	-
极限转速	极限转速	2100	r/min	-
重量	重量	18000	g	-
型号	型号	FYNT 90 F	-	-
基本轴承型号	基本轴承型号	22218 E	-	-

SKF FYNT 90 F图片

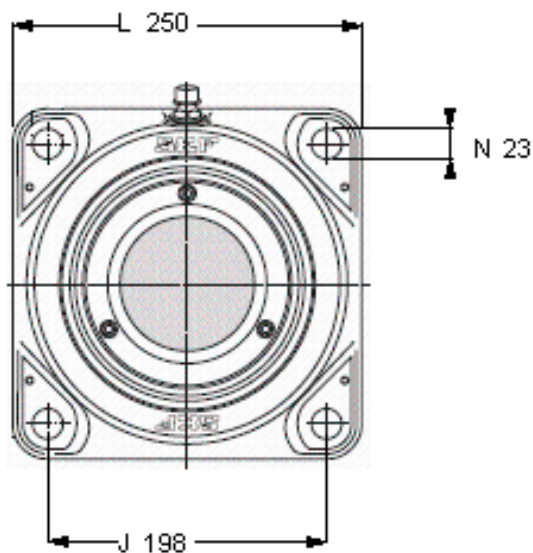
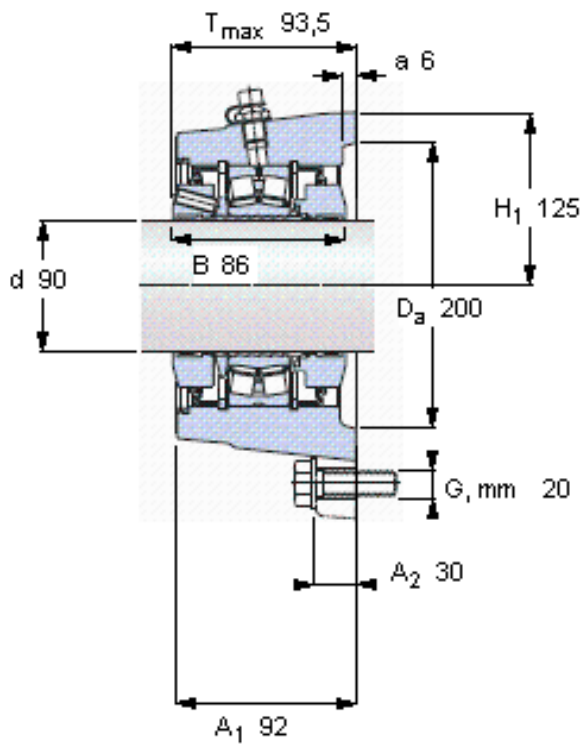

重新润滑脂量 [克]

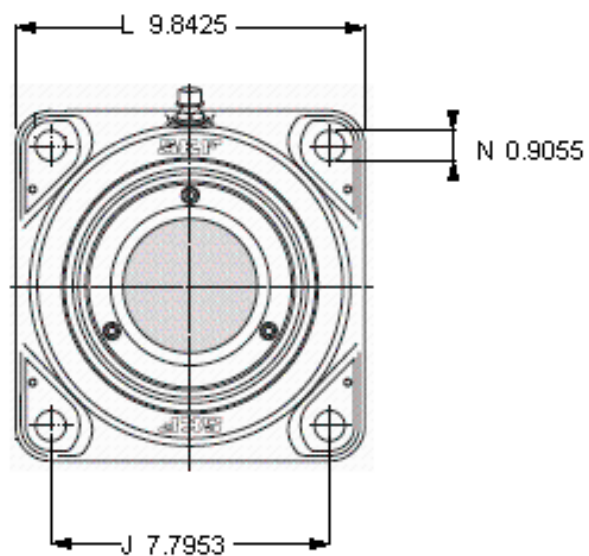
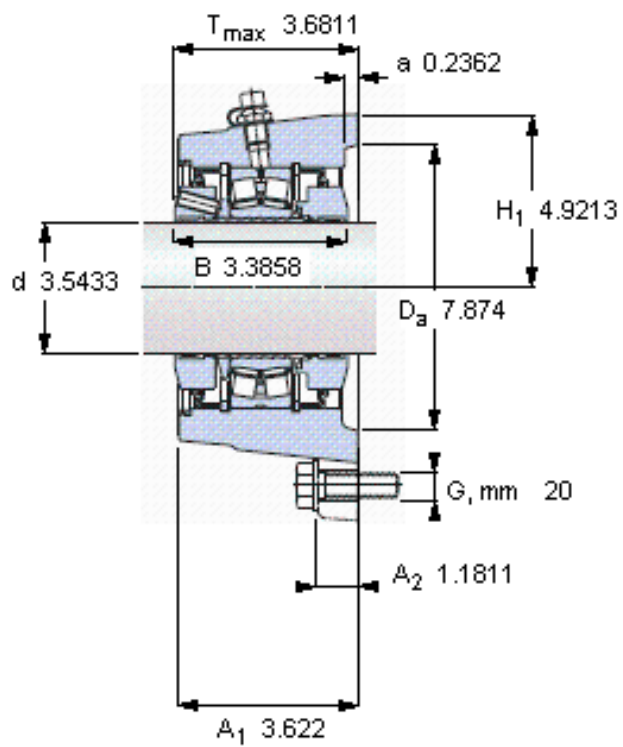

重新润滑脂量 [克]