

INA KWVE55-B-S参数

尺寸	H	70	mm	-
	B	100	mm	-
	L	173.6	mm	-
说明	1)			定位面
	2)			标记
	3)			根据 DIN 71 412-B M6 标准，带锥头的润滑嘴被松散提供
尺寸	A <sub>1</sub>	23.5	mm	-
	A <sub>2</sub>	12.5	mm	-
	A <sub>3</sub>	15	mm	-
	A <sub>4</sub>	15	mm	-
	a <sub>L</sub> max	107	mm	a L 和 a R 取决于导轨的长度 l max
	a <sub>L</sub> min	20	mm	a L 和 a R 取决于导轨的长度 l max
	a <sub>R</sub> max	107	mm	a L 和 a R 取决于导轨的长度 l max
	a <sub>R</sub> min	20	mm	a L 和 a R 取决于导轨的长度 l max
	b	53	mm	公差: -0,005 / -0,03
说明	G <sub>2</sub>	M12		根据 DIN ISO 4762-12.9的螺钉 最大锁紧力矩 (Nm) : M4 = 5 M5 = 10 M6 = 17 M8 = 41 M10 = 83 M12 = 140 M14 = 220 如有可能, 应有螺钉防松措施。
尺寸	H <sub>1</sub>	13.5	mm	-
	H <sub>5</sub>	11.25	mm	-
	h	41.5	mm	-
	h <sub>1</sub>	19.5	mm	-
	J <sub>B</sub>	75	mm	-

	$J_L$	75	mm	-
	$J_{L6}$	40.5	mm	-
	$j_L$	120	mm	-
说明	$K_1$	M14		根据 DIN ISO 4762-12.9的螺钉 最大锁紧力矩 (Nm) : M3 = 2,5 M4 = 5 M5 = 10 M6 = 17 M8 = 41 M10 = 83 M12 = 140 M14 = 220 M16 = 340 如有可能, 应有螺钉防松措施。
尺寸	$L_1$	132	mm	-
	$L_S$	2.2	mm	-
	$l_{max}$	2520	mm	单根导轨的最大长度; 更长的导轨可以分成几段供货, 并且相应地标注。根据合同约定, 单根导轨最大长度可达到6米。
	$N_3$	5.5	mm	最大允许的润滑连接螺纹深度: 7 mm
	$N_4$	5.5	mm	最大允许的润滑连接螺纹深度: 7 mm
	S	0.8	mm	-
	$T_5$	15	mm	-
	$W_6$	6	mm	距平面侧的宽度
重量	$m_W$	4350	g	滑块的质量
	$m_S$	14	kg/m	导轨的质量
说明				根据 DIN 636, 基本额定载荷的计算, 基本额定动载荷基于实践经验。
基本额定载荷	C	104000	N	基本额定动载荷
	$C_0$	213000	N	基本额定静载荷
额定静扭矩	$M_{0x}$	5600	Nm	绕 X 轴的额定静扭矩
	$M_{0y}$	2730	Nm	绕 Y 轴的额定静扭矩
	$M_{0z}$	2730	Nm	绕 Z 轴的额定静扭矩

INA KWVE55-B-S图片

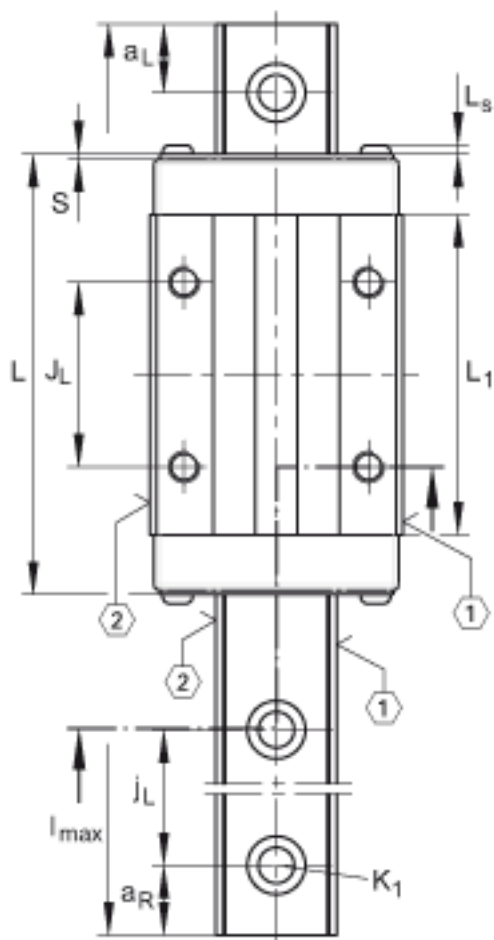
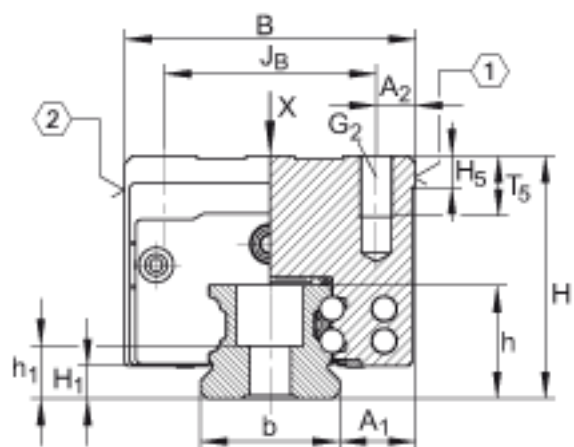
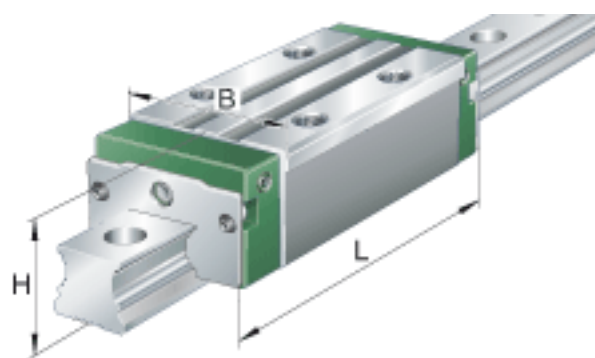

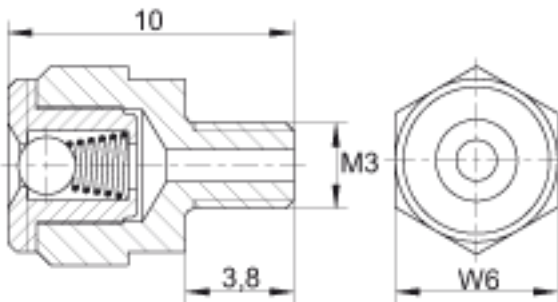
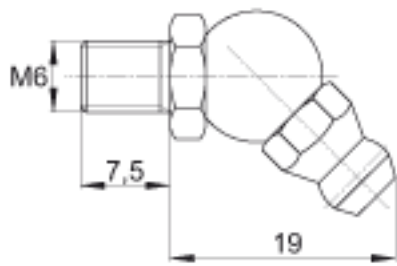
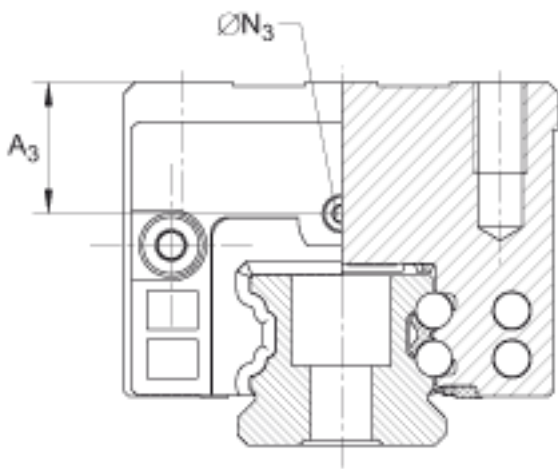
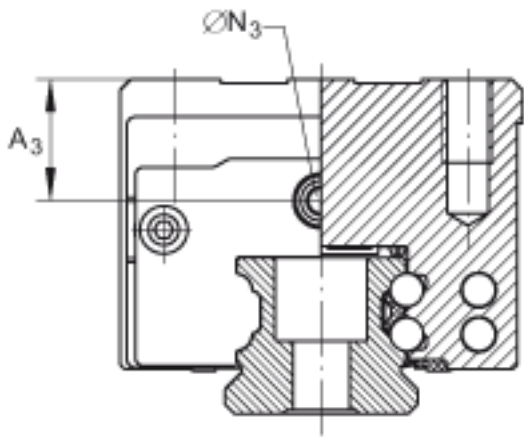

参考资料:<http://www.sozhou.com/p/c8ef46b2.html>

