

SKF 81222 TN参数

主要尺寸	d	110	mm	-
	D	160	mm	-
	H	38	mm	-
基本额定载荷	C	260000	N	动载荷
	C_0	1000000	N	静载荷
疲劳载荷极限	P_u	98000	N	-
最小载荷系数	A	0.066	-	-
额定转速	额定转度	850	r/min	-
	极限转速	1700	r/min	-
重量	重量	2300	g	-
型号	完整轴承	81222 TN	-	-
	滚子和保持架推力组件	K 81222 TN	-	-

SKF 81222 TN图片

完整轴承

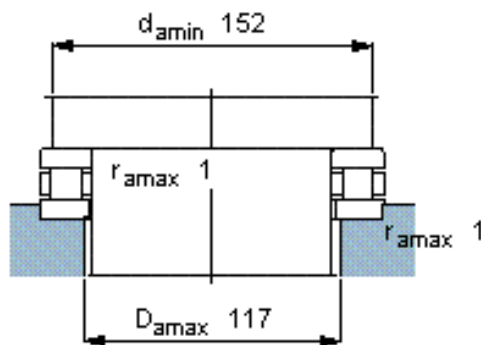
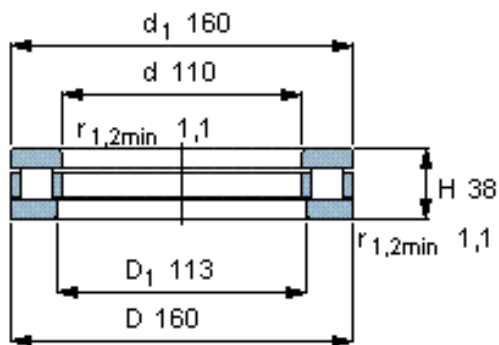

滚子和保持架推力组件

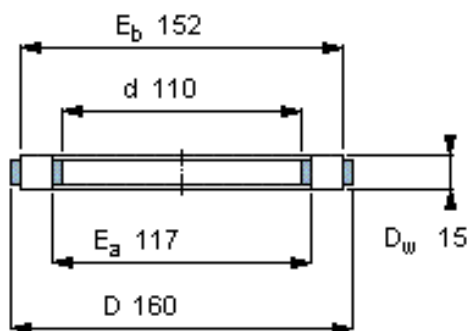

适宜的部件

轴垫圈
WS 81222

轴承座垫圈
GS 81222

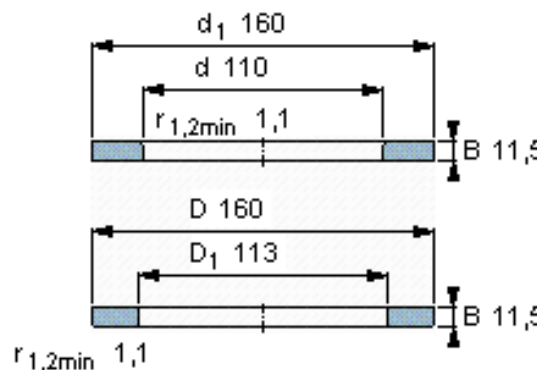

K 81222 TN

质量 kg 0,40

完整轴承

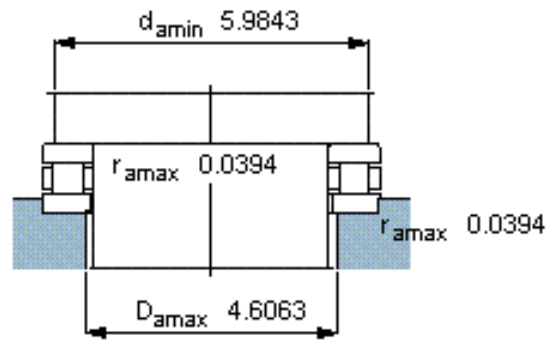
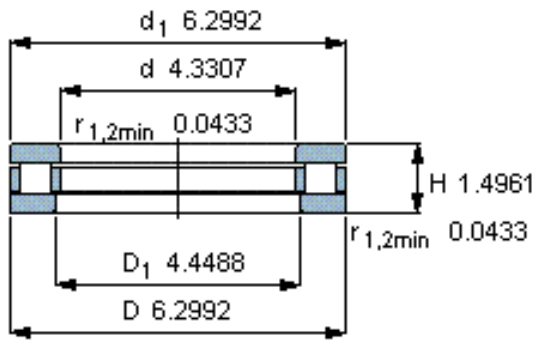

滚子和保持架推力组件

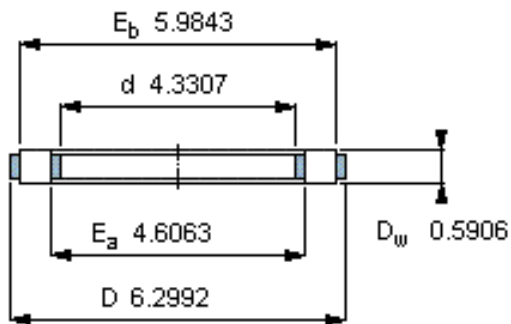

K 81222 TN

质量 kg 0,40

适宜的部件

轴垫圈
WS 81222

轴承座垫圈
GS 81222

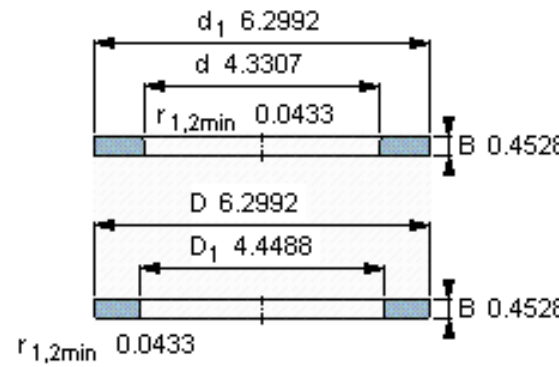

参考资料: <http://www.sozhou.com/p/dc3bc53a.html>