

SKF 81236 M参数

主要尺寸	d	180	mm	-
	D	250	mm	-
	H	56	mm	-
基本额定载荷	C	550000	N	动载荷
	C_0	2400000	N	静载荷
疲劳载荷极限	P_u	204000	N	-
最小载荷系数	A	0.46	-	-
额定转速	额定转度	560	r/min	-
	极限转速	1100	r/min	-
重量	重量	8250	g	-
型号	完整轴承	81236 M	-	-
	滚子和保持架推力组件	K 81236 M	-	-

SKF 81236 M图片

完整轴承

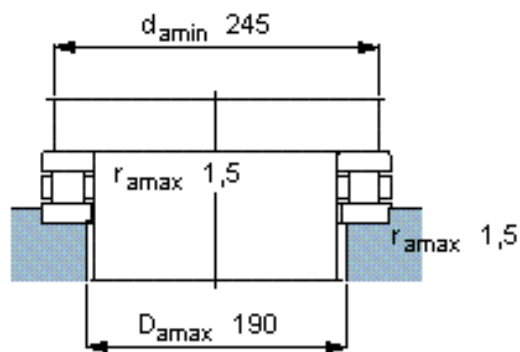
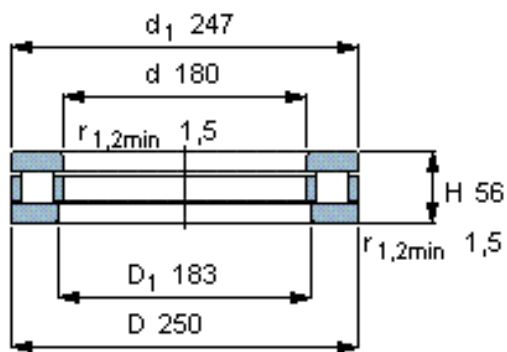

滚子和保持架推力组件

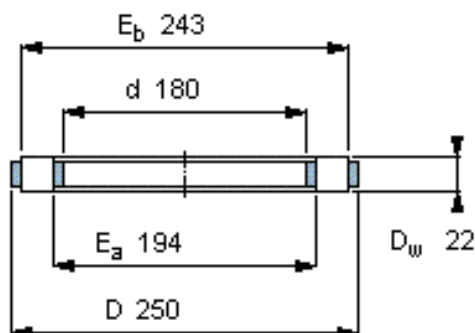

K 81236 M

质量 kg 2,14

适宜的部件

轴垫圈
WS 81236

轴承座垫圈
GS 81236

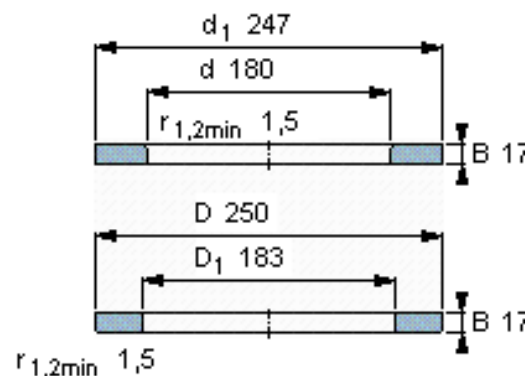

完整轴承

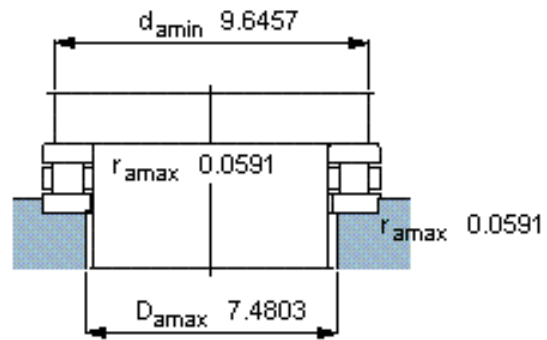
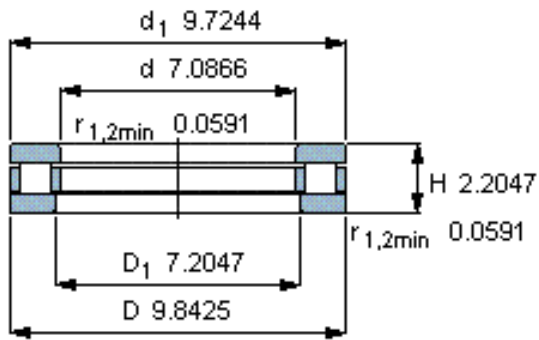

滚子和保持架推力组件

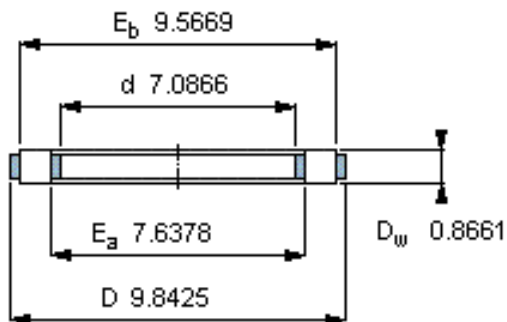

K 81236 M

质量 kg 2,14

适宜的部件

轴垫圈
WS 81236

轴承座垫圈
GS 81236

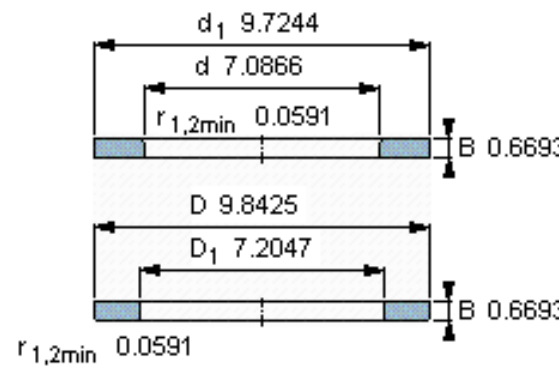

参考资料: <http://www.sozhou.com/p/f6ce0bed.html>